

PHILIPS

Ledinaire batten

BN021C

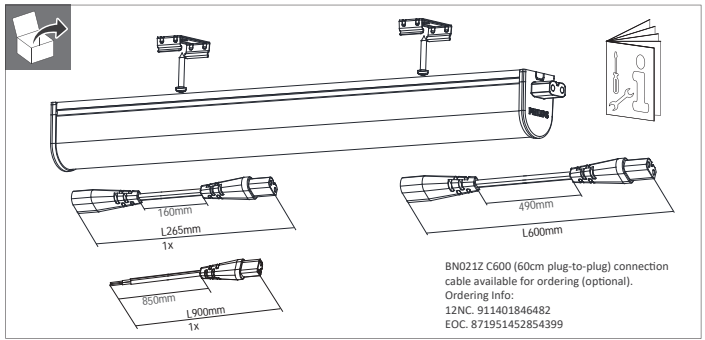

BN021C C600 (60cm plug-to-plug) connection cable available for ordering (optional).
 Ordering info:
 12NC: 911401846482
 EOC: 871951452854399



220V
240V

50Hz
60Hz





Max 40°C
Min -20°C

Ta 25°C

IP20

L65 B50
50k hrs



		System lumen (lm)	CCT (K)	Energy efficiency class of light source	P(W)	Length(mm)	
BN021C LED5S/840 L300	•	540	4000	D	5	326	0.06
BN021C LED5S/830 L300	•	480	3000	E			
BN021C LED10S/840 L600	•	1050	4000	D	10	586	0.09
BN021C LED10S/830 L600	•	960	3000	E			
BN021C LED16S/840 L900	•	1600	4000	D	15	886	0.13
BN021C LED14S/830 L900	•	1450	3000	E			
BN021C LED21S/840 L1200	•	2100	4000	D	20	1186	0.17
BN021C LED19S/830 L1200	•	1900	3000	E			
BN021C LED26S/840 L1500	•	2600	4000	D	24	1486	0.21
BN021C LED24S/830 L1500	•	2400	3000	E			

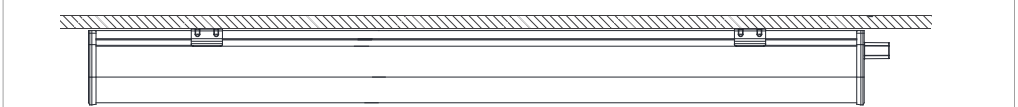
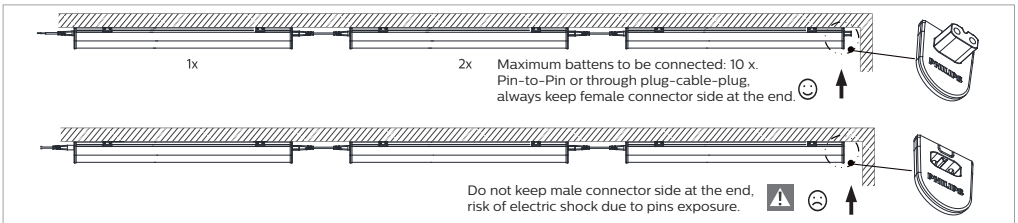
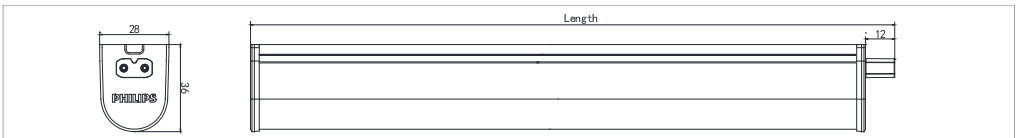

- The luminaire shall be installed by a qualified electrician and wired in accordance with the latest IEE electrical regulations or the national requirements.
- LED board & LED driver are not serviceable and not replaceable.
- The light source of this luminaire is not replaceable; when the light source reaches its end of life the whole luminaire shall be replaced.
- Luminaire must not be used or stored in corrosive environment where hazardous materials such as sulphur, chlorine, phthalates, etc. are present.
- If the external flexible cable or cord of this luminaire is damaged, it shall be replaced by a special cord or cord exclusively available from the manufacturer or his service agent.



ATTENTION
 OBSERVE PRECAUTIONS
 FOR HANDLING
 ELECTROSTATIC
 SENSITIVE
 DEVICES

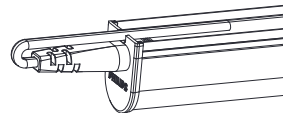
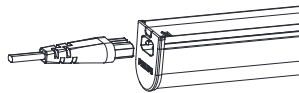
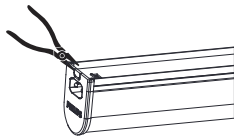

1

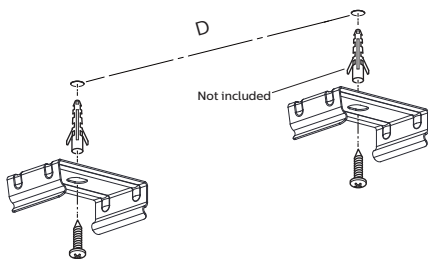

Type	L300	L600	L900	L1200	L1500
D/mm	200-250	350-450	500-650	700-850	850-1000

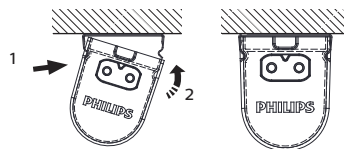

2

3

Inrush current

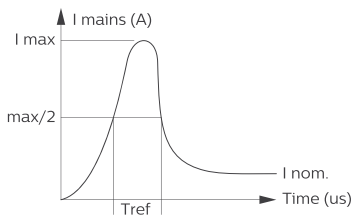

	LED5S	LED10S	LED15S	LED20S	LED25S
			LED14S	LED19S	LED24S
Electrical characteristics					
Imax (A)	8.7	9	11	14.3	16.8
Tref (µs)	1	1	1	1	1
MCB Luminaire Max					
B-10A	10	10	10	10	10
B-16A	10	10	10	10	10
C-10A	10	10	10	10	10
C-16A	10	10	10	10	10

4

© 03/2021 Signify Holding.

All rights reserved. This document contains information relating to the product portfolio of Signify which information may be subject to change. No representation or warranty as to the accuracy or completeness of the information included herein is given and any liability for any action in reliance thereon is disclaimed. The information presented in this document is not intended as any commercial offer and does not form part of any quotation or contract. Philips and the Philips Shield Emblem are registered trademarks of Koninklijke Philips N.V.. All other trademarks are owned by Signify Holding or their respective owners.

Signify Holding,
The Netherlands

GB	This product contains a light source of energy efficiency class: see table or label.	RO	Acest produs contine o sursă de lumină cu clasa de eficiență energetică: a se vedea tabelul sau eticheta.
ES	Este producto contiene una fuente luminosa de la clase de eficiencia energética: ver tabla o etiqueta.	CZ	Tento výrobek obsahuje světelný zdroj s třídou energetické účinnosti: viz tabulka nebo štítek.
PT	Este produto contém uma fonte de luz da classe de eficiência energética: ver tabela ou rótulo.	FI	Tämä tuote sisältää valonlähteen, jonka energiatehokkuusluokka on: katso taulukko tai etiketti.
DE	Dieses Produkt enthält eine Lichtquelle der Energieeffizienzklasse: siehe Tabelle oder Etikett.	SE	This Denna produkt innehåller en ljuskälla med energieffektivitetsklass: se tabell eller etikett.
FR	Ce produit conti nt une source lumineuse de classe d'efficacité énergétique: voir tableau ou étiquette.	HU	Ez a termék egy energiahatékonysági osztályú fényforrást tartalmaz: lásd a táblázatot vagy a címkét.
IT	Questo prodotto contiene una sorgente luminosa di classe di efficienza energetica: vedere tabella o etichetta.	SK	Tento výrobok obsahuje svetelný zdroj triedy energetické účinnosti: pozri tabuľku alebo štítok.
NL	Dit product bevat een lichtbron van energie-efficiëntieklasse: zie tabel of label.	HR	Ovaj proizvod sadržava izvor svetlosti klase energetske učinkovitosti: vidi tablicu ili naljepnicu.
DK	Denne produkt indeholder en lyskilde i energieeffektivitetsklasse: se table eller etiket.	LV	Šis ražojums satur gaismas avotu, kura energoefektivitātes klase ir: skatīt tabulu vai etiķeti.
LT	Šiame gaminyje yra šviesos šaltinis, kurio energijos vartojimo efektyvumo klasė: žr. lentelę arba etiketę.	EE	Toode sisaldab energiatõhususe klassi valgusallikat: vt tabelit või etiketti.
PL	To προϊόν αυτό περιέχει φωτεινή πηγή της τάξης ενεργειακής απόδοσης: βλέπε πίνακα ή ετικέτα.	BG	Този продукт включва светлинен източник с клас на енергийна ефективност: вижте таблицата или етикета.
GR	Ten produkt zawiera źródło światła o klasie efektywności energetycznej: patrz tabela lub etykieta.	SI	Ta izdelek vsebuje svetlobni vir razreda energijske učinkovitosti: glej tabelo ali nalepko.
GB	If this luminaire contains an external flexible cable, it shall only be replaced by the manufacturer or his service agent or a similar qualified person. The light source and/or control gear contained in this luminaire are not replaceable, in case of damage replace the luminaire.		
ES	Si esta luminaria contiene un cable flexible, solo podrá ser sustituido por el fabricante o su agente de servicio o por una persona cualificada. El driver y/o la fuente de luz contenidos en esta luminaria no son reemplazables, en caso de defecto se reemplazará la luminaria.		
PT	Se esta luminária tiver um cabo externo flexível, só deve ser substituída pelo fabricante ou pelo seu agente de serviço ou por pessoa qualificada para tal. A fonte de luz e/ou o equipamento controlo nesta luminária não são substituíveis, em caso de avaria, substitua a luminária.		
DE	Wenn die Leuchte ein externes flexibles Anschlusskabel beinhaltet, darf dieses nur durch den Hersteller oder seinen Kundendienst oder eine ähnlich qualifizierte Person ausgetauscht werden. Die in dieser Leuchte enthaltene Lichtquelle und/oder Betriebsgerät ist nicht austauschbar, im Schadensfall ersetzen Sie die Leuchte.		
FR	Si ce luminaire comporte un câble d'alimentation souple, celui-ci ne doit être remplacé que par le fabriquant, un de ses agents ou une personne qualifiée. La source lumineuse et/ou le contrôleur de courant contenus dans ce luminaire ne sont pas remplaçables, changez le produit en cas de défaut.		
HU	Amennyiben a lámpatest tartalmaz külső rugalmas kábelt, azt csak a gyártó, a gyártóval szerződött cég vagy megfelelő képzéssel rendelkező szakember cserélheti ki. A fényforrás és/vagy a működtető szerelvény ebben a lámpatestben nem cserélhető, meghibásodás esetén cserélje a teljes lámpatestet.		
NL	Indien de armatuur een flexibele voedingskabel bevat, mag deze alleen vervangen worden door de fabrikant of haar service dealer of een vergelijkbaar gekwalificeerd persoon. De lichtbron en/of voorschakelapparatuur van dit armatuur zijn niet vervangbaar, in geval van defect dient het armatuur vervangen te worden.		
DK	Hvis dette armatur indeholder eksterne kabler må de kun blive udskiftet af producenten eller hans service partner eller lignende kvalificeret person. Lyskilden og/eller driver indeholdt i dette armatur er ikke udskiftelig, i tilfælde af skade skift hele armaturet.		
SE	Om denna armatur har en extern kabel får den endast bytas ut av tillverkaren eller en kvalificerad person. Ljuskällan och/eller styrsystemet är inte utbytbart. Vid skada ska därför hela armaturen bytas ut.		

- NO Hvis dette armaturet inneholder en ekstern kabel, skal den bare erstattes av produsenten eller dens service agent eller tilsvarende kvalifisert person. Lyskilden og/eller driveren i dette armaturet er ikke mulig å erstatte, hvis den er ødelagt må armaturet byttes ut.
- CZ Pokud toto svítidlo obsahuje napájecí flexibilní kabel, může jej vyměnit pouze výrobce nebo jeho servisní technik nebo obdobně kvalifikovaná osoba. Světelný zdroj a/nebo předřadník obsažený v tomto svítidle nelze vyměnit, v případě poškození vyměňte celé svítidlo.
- FI Jos tässä valaisimessa on ulkoinen kaapeli, sen saa vaihtaa vain valmistaja tai tämän valtuuttama huoltoedustaja tai vastaava pätevä henkilö. Tämän valaisimen sisältämät valonlähteet ja/tai liitäntälaitteet eivät ole vaihdettavissa, vaihda valaisin niiden vikaantuessa.
- PL Jeśli ta oprawa zawiera zewnętrzny przewód, powinien on być wymieniony tylko przez producenta lub jego serwisanta lub kwalifikowany personel. Źródła światła i/lub zasilacz ww oprawie nie są wymienne, w przypadku uszkodzenia należy wymienić oprawę.
- RO Dacă acest aparat de iluminat conține un cablu flexibil extern, acesta trebuie înlocuit doar de producător sau de agentul său de service sau de o persoană similară calificată. Sursa de lumină și / sau aparatul conținut în acest aparat de iluminat nu pot fi înlocuite, în caz de deteriorare înlocuiți aparatul de iluminat.
- IT Se tale apparecchio di illuminazione contiene un cavo flessibile esterno, esso deve essere sostituito solo dal costruttore o dal suo agente di servizio o da una persona qualificata analoga. La sorgente luminosa e/o il dispositivo di controllo contenuti in questo apparecchio di illuminazione non sono sostituibili, in caso di danni sostituire l'intero apparecchio di illuminazione.
- TR Bu aydınlatma armatürü harici bir esnek kablo içeriyorsa, yalnızca imalatçı veya servis temsilcisi veya benzer nitelikli bir kişi tarafından değiştirilmelidir. Bu armatürde bulunan ışık kaynağı ve / veya kontrol tertibatı değiştirilemez, hasar olmasi durumunda armatürü değiştiriniz.
- HR Ako svjetiljka sadrži vanjski fleksibilni napojni kabel, smije ga zamijeniti samo proizvođač, ovlašteni serviser ili adekvatna stručno osposobljena i ovlaštena osoba. Izvor svjetlosti i / ili predspojna naprava sadržani u ovoj svjetiljki nisu zamjenjivi, u slučaju njihovog kvara, zamijeniti cijelu svjetiljku
- GR Εάν το φωτιστικό αυτό περιέχει εξωτερικό εύκαμπτο καλώδιο, αντικαθίσταται μόνο από τον κατασκευαστή ή τον αντιπρόσωπο σέρβις ή παρόμοιο ειδικευμένο πρόσωπο. Η φωτεινή πηγή ή/και τα όργανο έναυσης/ελέγχου που περιέχεται σε αυτό το φωτιστικό δεν είναι αντικαταστάσιμα, σε περίπτωση βλάβης αντικαταστήστε το φωτιστικό.
- BG Ако това осветително тяло съдържа външен гъвкав кабел, той трябва да бъде заменено само от производителя или неговия оторизиран сервиз или подобно квалифицирано лице. Съдържащият се в това осветително тяло източник на светлина и / или пусково-регулируща апаратура не могат да се сменят, в случай на повреда заменете цялото осветителното тяло.
- RU Если этот светильник содержит внешний гибкий кабель, его может заменить только производитель, его сервисный агент или другое квалифицированное лицо. Источник света и / или ПРА, содержащиеся в этом светильнике, не подлежат замене, в случае повреждения за светильник.